

HDC400
HYDRAULIC COMPRESSOR
PAGE 2

TCF8BX
CONDENSER BOX
PAGE 10

TFC8BX
EVAPORATOR UNIT
PAGE 20

DRIER PLATE ASSEMBLY
PAGE 30

ENGINE DRIVEN A/C SYSTEM
PAGE 34

A/C HARNESS
PAGE 39

REBUILD UNITS
PAGE 42

A/C MIDLIFE KITS
PAGE 43

HOSE KIT
PAGE 44

MINING WORK LIGHTS
PAGE 45



**CAT & TEREX DIGGERS AIR CONDITIONING
PARTS CATALOGUE VER 2.0**

AUTOTECH
MINING



SUPPLY CAT & TEREX SIGMA AUTO AIR CONDITIONING UNITS &
SPARE PARTS AT COMPETITIVE PRICING



REBUILD EVAPORATOR & CONDENSER UNITS, HOSE KIT
MAINTENANCE FREE CONDENSER FAN



Parts Enquiry: admin@autotechmining.com.au

0412 228 671

HDC 400 DUAL HYDRAULIC COMPRESSOR ASSEMBLY

DIAGRAM 1

Note: Items numbered are listed in spare parts table



DIAGRAM 2

Note: Items numbered are listed in spare parts table

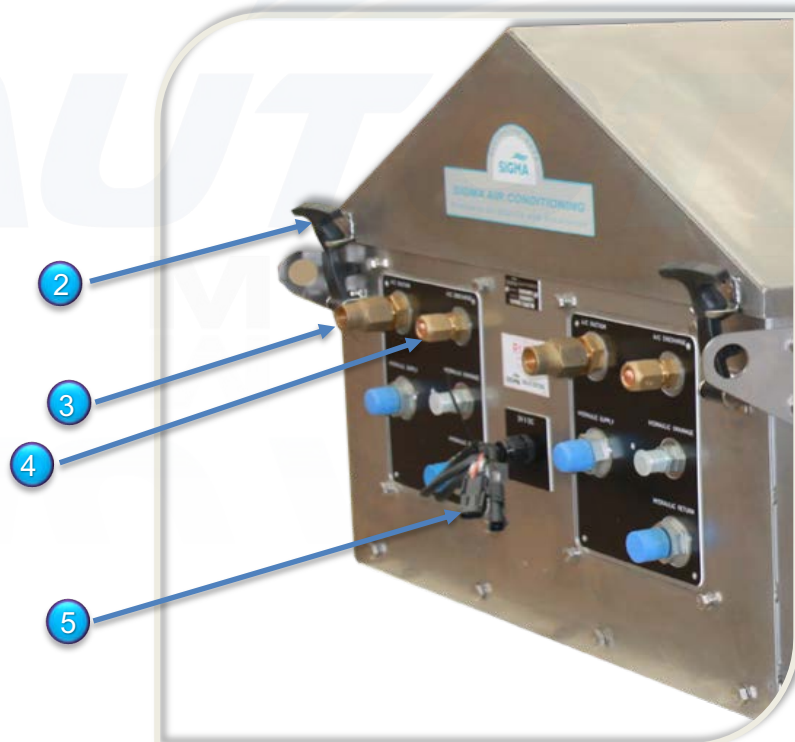

SPARE PARTS
DIAGRAM 1 – DIAGRAM 2





ITEM NO	DESCRIPTION	AUTO TECH PN	QTY	PHOTO
1	SIGMA DUAL HYDRAULIC COMPRESSOR UNIT HDC400 MODEL CAT & TEREX DIGGERS	HDC400	1	PAGE 1 DIAGRAM 1
2	COMPRESSOR BOX LID LATCHES HDC400	AU851590	4	
3	BULKHEAD FITTING SIZE 12 ORING	FIT-BKH-MIO-12	2	
4	BULKHEAD FITTING SIZE 10 ORING	FIT-BKH-MIO-10	2	
5	HDC400 UNIT HARNESS SUIT YELLOW HYDRAULIC BLOCK TYPE	HRN-HDC400-Y	2	
5	HDC400 UNIT HARNESS SUIT SILVER HYDRAULIC BLOCK TYPE	HRN-HDC400-S	2	

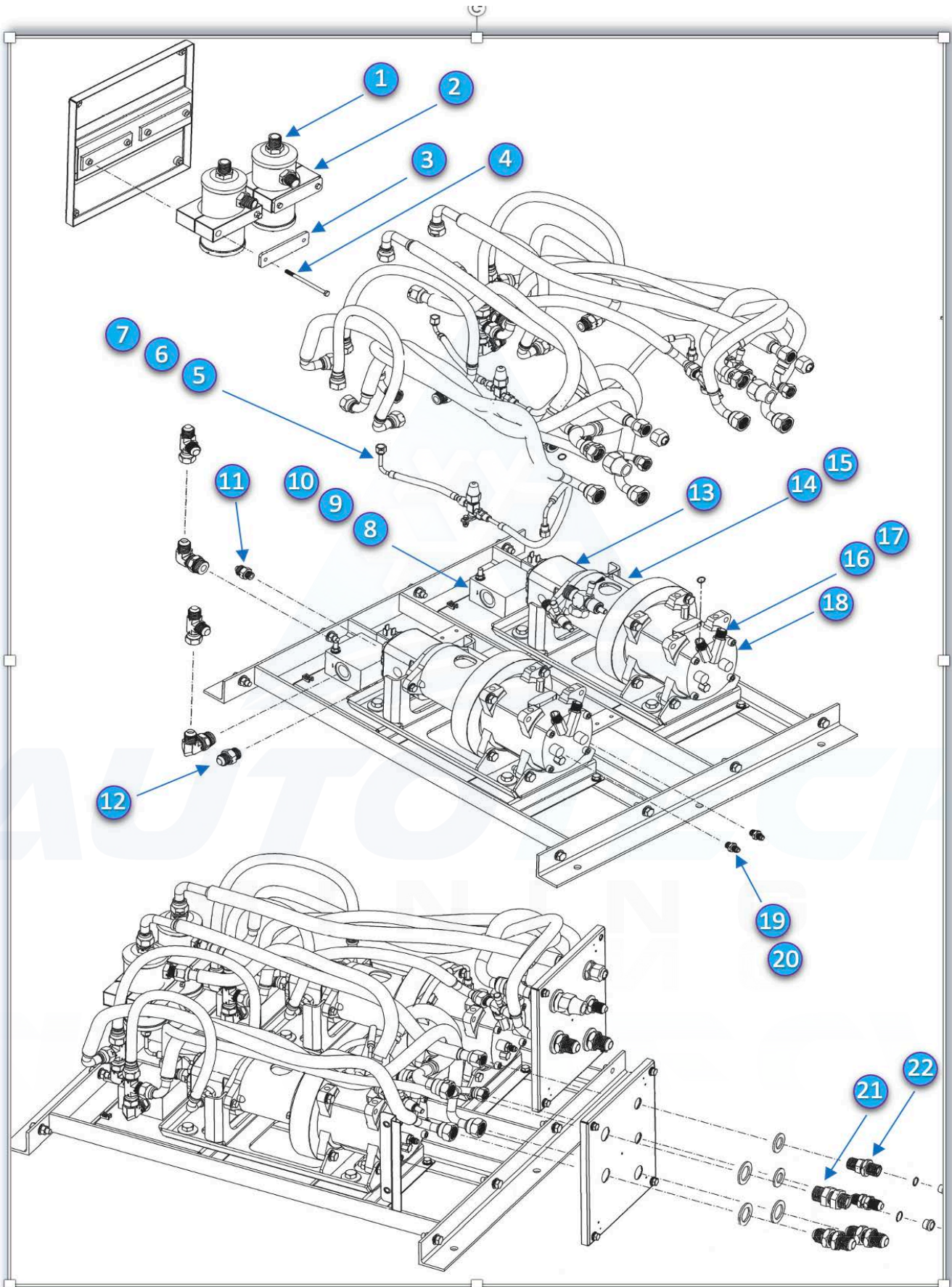



DIAGRAM 3



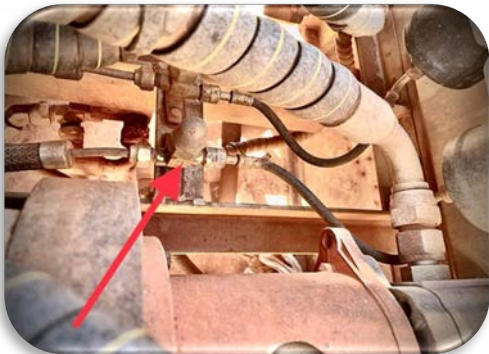

Note: Items numbered are listed in spare parts table





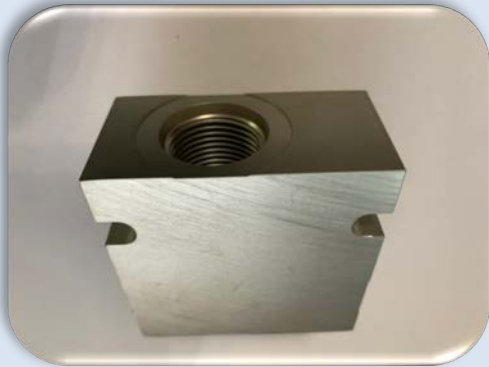

SPARE PARTS
DIAGRAM 3

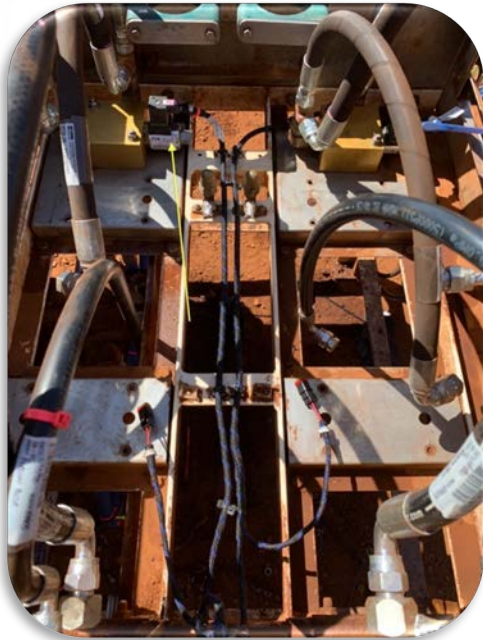



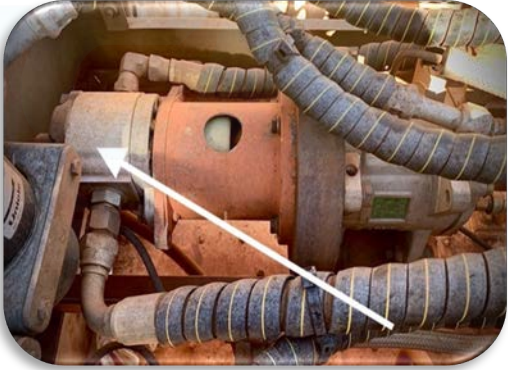

ITEM NO	DESCRIPTION	AUTO TECH PN	QTY	PHOTO
1	OIL SEPARATOR	OSUBMIO -10	2	
2,3,4*	OIL SEPARATOR CLAMP KIT	ATCLPOS10-KIT	1	
5	OIL SEPARATOR SHORT HOSE OIL SEPARATOR TO ISOLATION VALVE	AS3874506	2	
6	OIL SEPARATOR ISOLATION VALVE	AU517202	2	 

<p>7</p>	<p>OIL SEPARATOR LONG HOSE FROM ISOLATION VALVE TO COMPRESSOR</p>	<p>AS160182</p>	<p>2</p>	 
<p>8A</p>	<p>YELLOW HYDRAULIC VALVE BODY</p>	<p>AU522003</p>	<p>2</p>	 

<p>8B</p>	<p>SILVER HYDRAULIC VALVE BODY</p>	<p>AU522253</p>	<p>2</p>	
<p>9A</p>	<p>CARTRIDGE SUIT YELLOW HYDRAULIC VALVE BODY</p>	<p>AU522000</p>	<p>2</p>	
<p>9B</p>	<p>CARTRIDGE SUIT SILVER HYDRAULIC VALVE BODY</p>	<p>AU522252</p>	<p>2</p>	
<p>10A</p>	<p>COIL SUIT YELLOW HYDRAULIC VALVE BODY</p>	<p>AU522001</p>	<p>2</p>	 

<p>10B</p>	<p>COIL SUIT SILVER HYDRAULIC VALVE BODY</p>	<p>AU522311</p>	<p>2</p>	
<p>11</p>	<p>HYDRAULIC MOTOR CASE DRAIN ADAPTOR FITTING</p>	<p>AU512716</p>	<p>4</p>	
<p>12</p>	<p>HYDRAULIC MOTOR ADAPTOR FITTING</p>	<p>AU512715</p>	<p>4</p>	
<p>13</p>	<p>HYDRAULIC MOTOR</p>	<p>AU340000</p>	<p>2</p>	
<p>14</p>	<p>COMPRESSOR FEMALE COUPLING</p>	<p>AS509744</p>	<p>2</p>	

15	COMPRESSOR MALE COUPLING	AS509742	2	
16	LOW SIDE SERVICE VALVE	AU230644	2	
17	HIGH SIDE SERVICE VALVE	AU230640	2	
18	COMPRESSOR WITHOUT CLUTCH	CMUP200E VN-24	2	
19*	COMPRESSOR SWITCH ADAPTOR	ADP-HPS- UNCL	2	
20*	HIGH PRESSURE SWITCH	AU523655	2	
21	BULKHEAD SIZE 12 ORING	FIT-BKH-MIO- 12	2	



22	BULKHEAD SIZE 10 ORING	FIT-BKH-MIO-10	2	
23	HYDRAULIC FLOW CONTROL	VLV-FC400	2	 
19,20	HP SWITCH & ADAPTOR KIT	SW-HP-24K-4FF-K	2	 
16,17	SERVICE VALVES HIGH & LOW KIT	SVLV-10-12-K	2	 

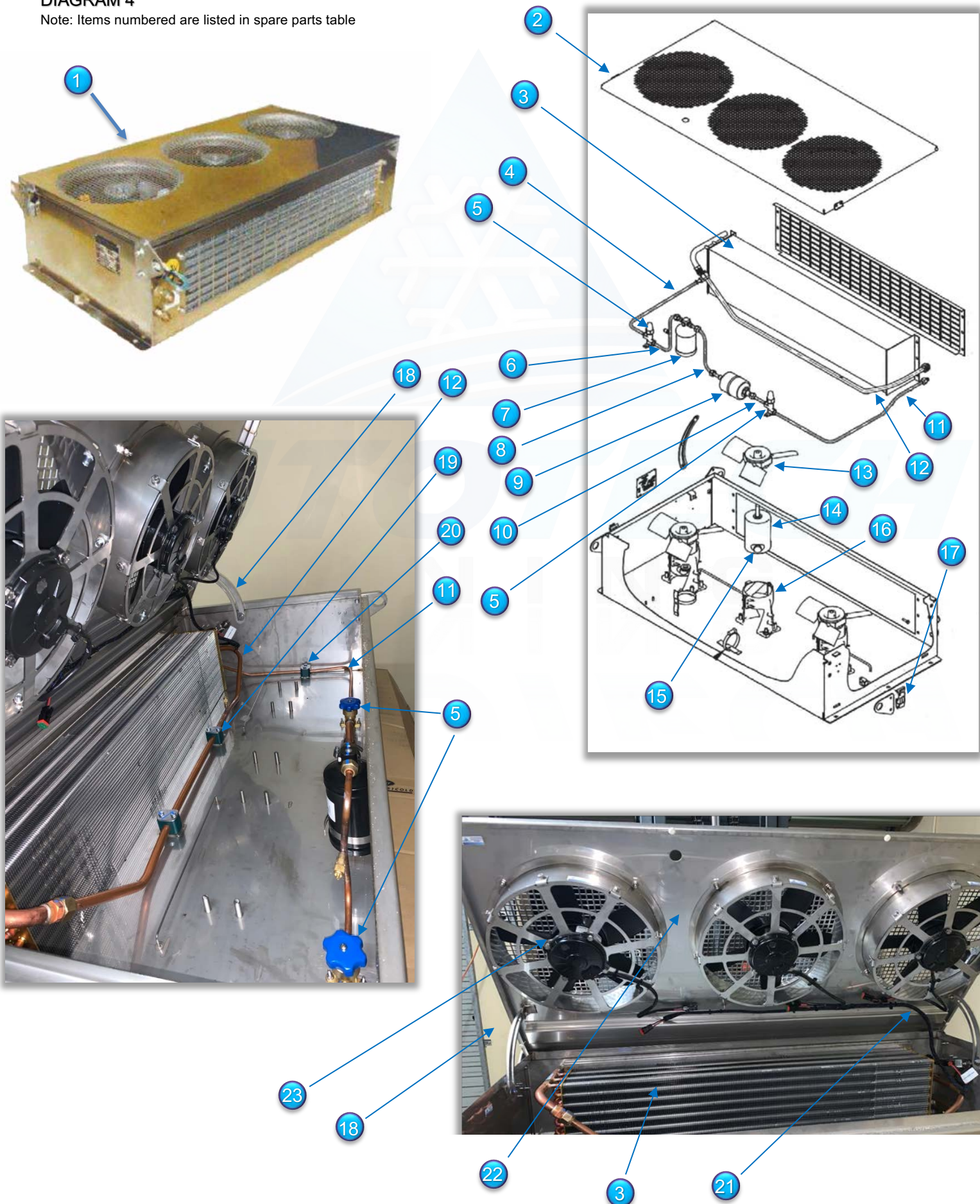

CONDENSER TCF8BX1 / TCF8BX2 WITH UPGRADED MAINTENANCE FREE FANS

DIAGRAM 4

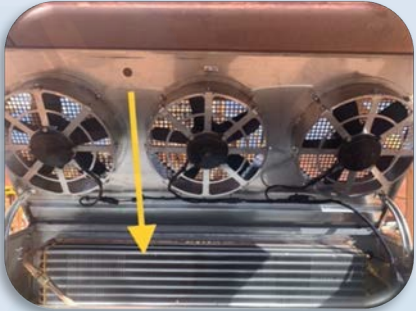
Note: Items numbered are listed in spare parts table



ITEM NO	DESCRIPTION	AUTO TECH PN	QTY	PHOTO
1	SIGMA CONDENSER UNIT CAT & TEREX DIGGERS	TCFBX1 TCFBX2	1	PAGE 10 DIAGRAM 4
2	LID ONLY SUIT MAINTENANCE FREE FANS	AS520725-LID	1	
3	CONDENSER COIL	AU110009	1	
4*	PIPE FROM CONDENSER TO ISOLATION VALVE	AS327817 REFER TO PAGE 19	1	
5	UPGRADED ISOLATION VALVE - FLARE	VLV-MF-06-HN	2	



<p>6*</p>	<p>UPGRADED PIPE FROM ISOLATION VALVE TO DRIER FILTER</p>	<p>AS327818 REFER TO PAGE 19</p>	<p>1</p>	 
<p>7</p>	<p>DRIER FILTER - FLARE</p>	<p>DR-38MF165</p>	<p>1</p>	

8*	PIPE FROM DRIER FILTER TO IN LINE FILTER SUIT BOTH IN LINE FILTER SIZES	REFER TO PAGE 19	1	
9*	IN LINE FILTER - FLARE	DR-INL38MF-33	1	
9*	IN LINE FILTER - FLARE	DR-INL38MF-83	1	
10*	UPGRADED FLARE PIPE FROM IN LINE FILTER TO ISOLATION VALVE	REFER TO PAGE 19	1	
11*	UPGRADED PIPE FROM ISOLATION VALVE TO BULKHEAD	REFER TO PAGE 19	1	

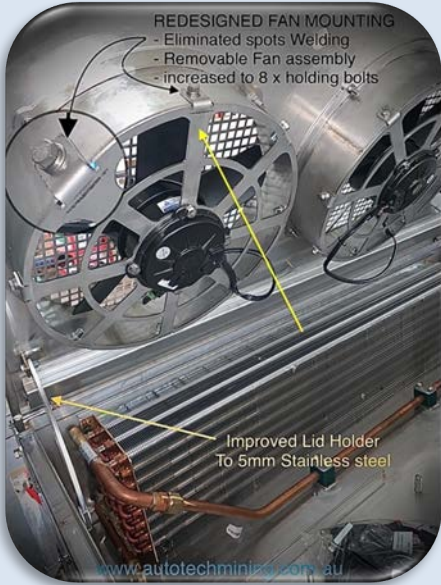

<p>12*</p>	<p>PIPE FROM BULKHEAD TO CONDENSER 5/8"</p>	<p>REFER TO PAGE 19</p>	<p>1</p>	
<p>13</p>	<p>BRUSHED FAN BLADE</p>	<p>AU420229</p>	<p>3</p>	
<p>14</p>	<p>BRUSH CONDENSER FAN</p>	<p>H0039230</p>	<p>3</p>	
<p>15</p>	<p>BRUSH</p>	<p>AU320622</p>	<p>6</p>	

16	BRUSH FAN BRACKET	UC028	6	
17	LID LATCH	AU851593	2	
18	UPGRADED HEAVY DUTY LID HOLDER	TCF- LID - HLDR	2	
19	PIPE CLAMP KIT SIZE 5/8	ATCLP10-KIT	2	
20	PIPE CLAMP KIT SIZE 3/8	ATCLP6-KIT	1	

21	CONDENSER UPGRADED HARNESS WITH 60A PLUG	HRN- TCF8BX	1	 
				
22**	FAN MOUNTING BASE	ATFM- 12T8B	3	

<p>23**</p>	<p>MAINTENANCE FREE FAN WITHOUT BASE</p>	<p>ATFM-12PLT8</p>	<p>3</p>	
<p>23**</p>	<p>MAINTENANCE FREE FAN & MOUNTING BASE ASSEMBLY</p>	<p>ATFM-12PLCS</p>	<p>3</p>	

<p>BULKHEAD INPUT FITTING FLRAE</p>	<p>FIT-BKH-MF- 10</p>	<p>1</p>	
<p>BULKHEAD OUTPUT FITTING FLRAE</p>	<p>FIT-BKH-MF- 06</p>	<p>1</p>	
<p>BULKHEAD INPUT FITTING ORING</p>	<p>FIT-BKH-MIO- 10</p>	<p>1</p>	
<p>BULKHEAD OUTPUT FITTING ORING</p>	<p>FIT-BKH-MIO- 06</p>	<p>1</p>	
<p>CONDENSER CABLE GLAND</p>	<p>GLN - 20</p>	<p>1</p>	

*	UPGRADED CONDENSER PIPE KIT INCLUDES ALL PIPES - FLARE	TCF8-FP	1	
*	UPGRADED CONDENSER PIPE & ISOLATION VALVES KIT	TCF8-FP-KIT	1	INCLUDES CONDENSER PIPE KIT & 2 X ISOLATION VALVE
**	UPGRADED LID & 3 MAINTENACE FREE FANS	TCF-FMLD	1	
***	POWER CABLE FROM CAB TO CONDENSER BOX FRONT A/C	HRN-TCF8BX-P/F	1	INCLUDES HEAVY DUTY CONNRCTORS KIT
***	POWER CABLE FROM CAB TO CONDENSER BOX REAR A/C	HRN-TCF8BX-P/R	1	INCLUDES HEAVY DUTY CONNECTORS KIT

CEILING EVAPORATOR TFC8BX1 / TFC8BX2 WITH HEATING ASSEMBLY

DIAGRAM 5

Note: Items numbered are listed in spare parts table

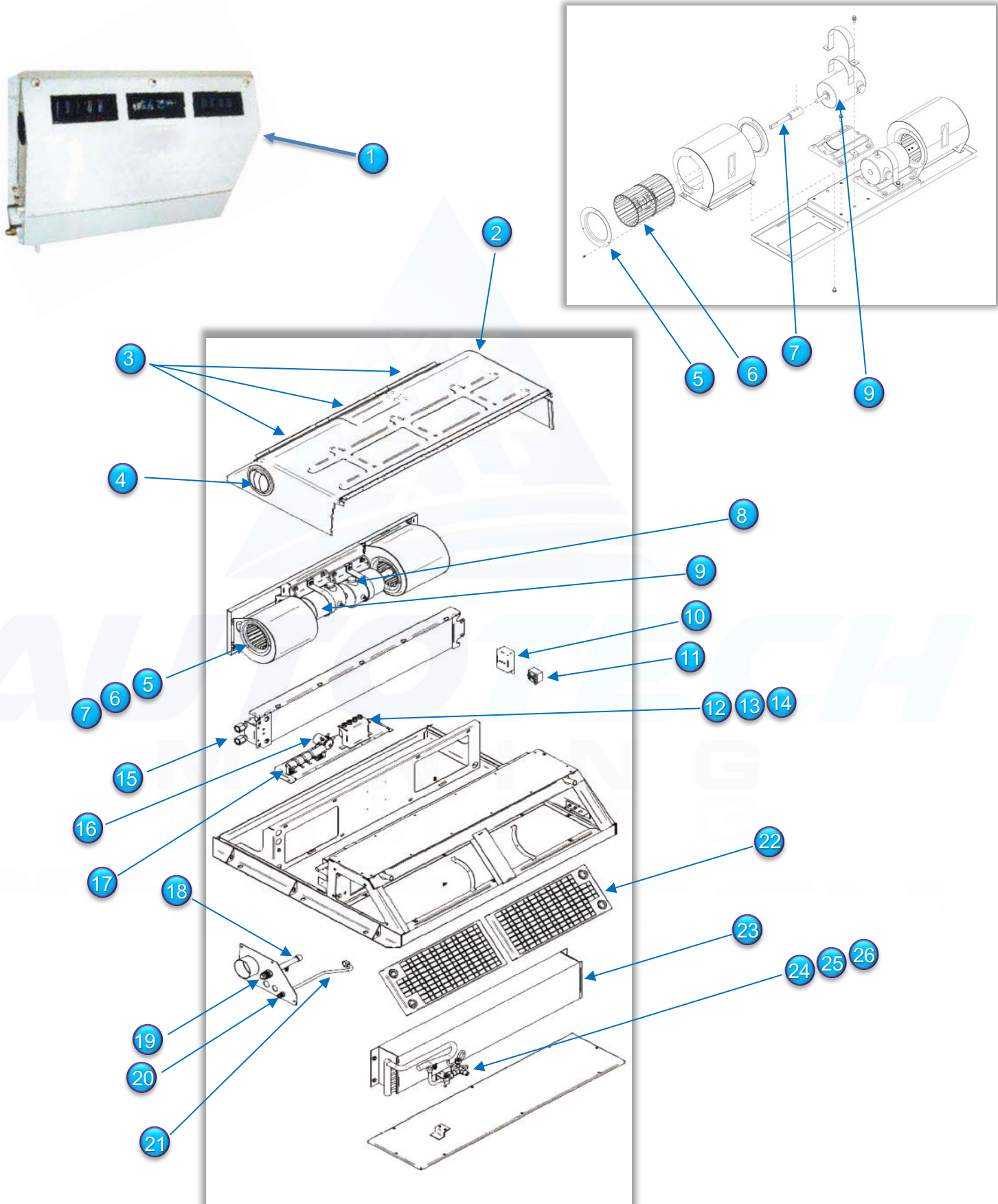

DIAGRAM 6

Note: Items numbered are listed in spare parts table

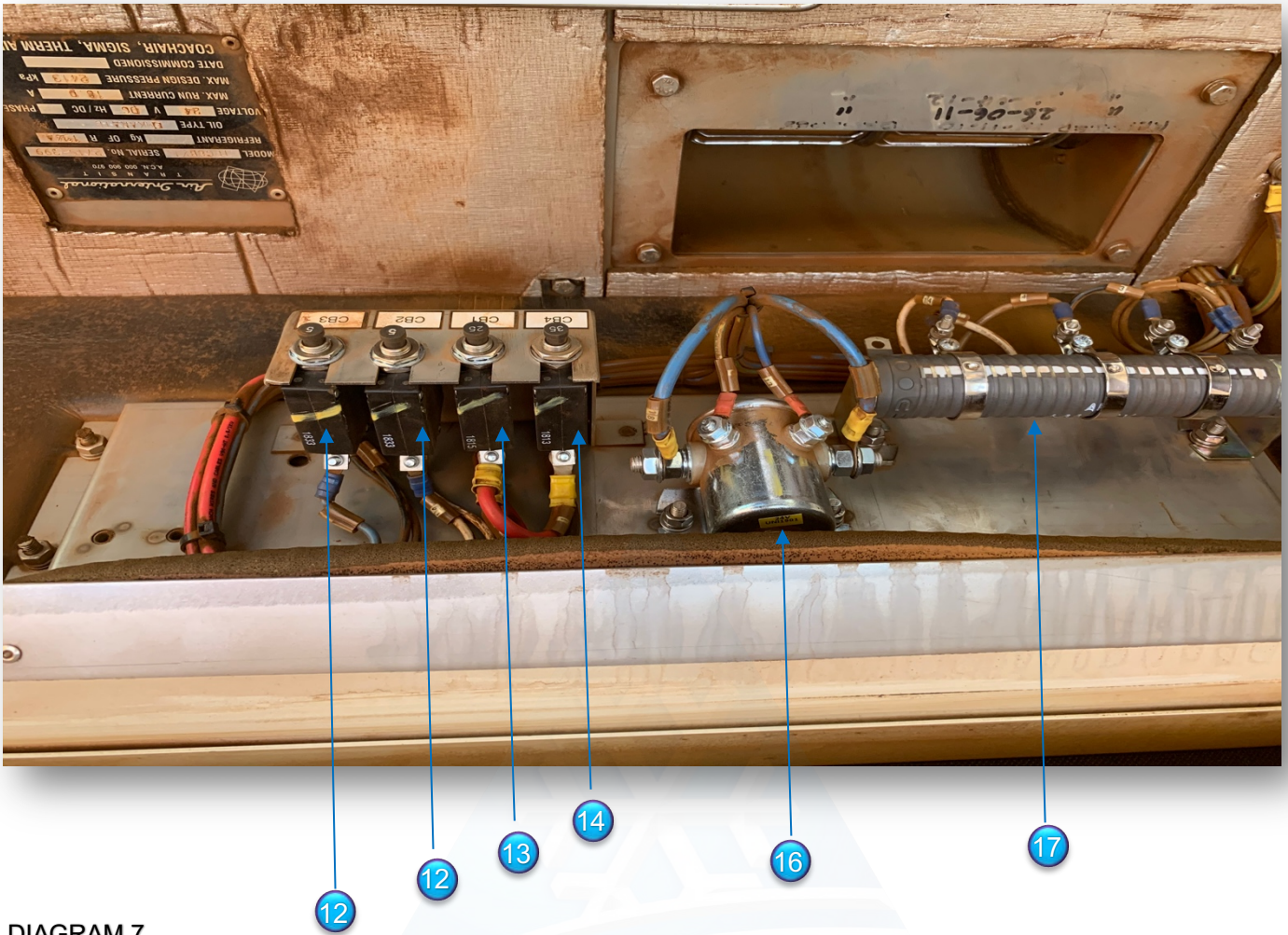

DIAGRAM 7

Note: Items numbered are listed in spare parts table

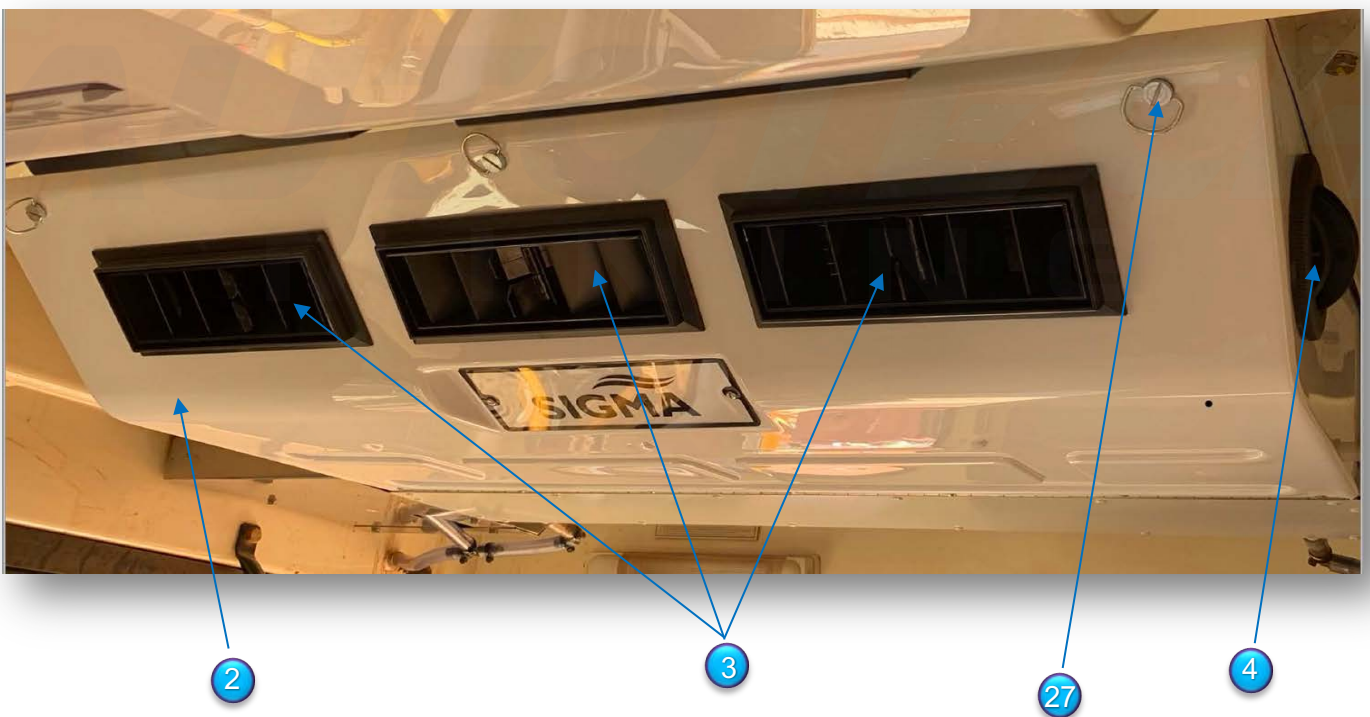

DIAGRAM 8

Note: Items numbered are listed in spare parts table



28

29

30

31



SPARE PARTS
DIAGRAM 5, 6, 7, 8

ITEM NO	DESCRIPTION	AUTO TECH PN	QTY	PHOTO
1	CEILING EVAPORATOR UNIT MODEL TFC8BX	TFC8BX1	1	PAGE 20 DIAGRAM 5
2	EVAPORATOR PLASTIC COVER	S2715031	1	
3	FRONT VENT - DIFFUSER	UC901	3	
4	SIDE ROUND DIFFUSER	AU821300	2	
5	INLET RING	AU410902	4	
6	EVAPORATOR BLOWER WHEEL	AU410105	2	



7	EVAP FAN EXTENTION SHAFT	AU872135	2	
8	FAN BRUSHES	AU320622	4	
9	EVAPORATOR FAN	UE026G	2	
10	ELECTRIC THERMOSTAT WITH POT	AU681925	1	
11	DE-ICE THERMOSTAT	UE016	1	
12	EVAPORATOR CIRCUIT BREAKER 5A	AU641C1111	2	

13	EVAPORATOR CIRCUIT BREAKER 25A	AU641065	1	
14	EVAPORATOR CIRCUIT BREAKER 35A	AU641067	1	
15	HEATER COIL	AU130009	1	
16	EVAPORATOR SOLENOID	UE072	1	
17	FAN SPEED RESISTOR	AU692107	1	
18	EVAPORATOR OUTLET PIPE	AS271574	1	
19	EVAPORATOR SIDE PLATE OUTLET BULKHEAD	FIT-BKH-MF-12	1	

20	EVAPORATOR SIDE PLATE INLET BULKHEAD	FIT-BKH-MF-06	1	
21	EVAPORATOR INLET PIPE FLARE	AS271575	1	
22	UPGRADED CAB FILTER WITH GROMMET	AS271535S	2	
23	EVAPORATOR COIL	AU120394	1	
24	TX VALVE	AU521509	1	
25	ORIFICE	AU521508	1	

26	LP SWITCH	AU523365	1	
27	EVAPORATOR COVER FASTENER CLIP	UC031	3	
29	CAB ARMREST AC HARNESS KIT	HDP-18-8-KIT	1	
30	POT THERMOSTAT SWITCH	AU681926	1	
31	FAN SPEED CONTROL SWITCH	AU663563	1	
32	MODE SWITCH	AU663569	1	

27*	EVAPORATOR COVER CLIP RETAINER	AU912924	3	
	EVAPORATOR SHUTOFF VALVE	AU522061	1	
	EVAPORATOR SHUTOFF VALVE COIL	AU668140	1	
	EVAPORATOR SHUTOFF VALVE ADAPTOR MALE FLARE	ADP-FF-06	1	
	EVAPORATOR SHUTOFF VALVE ADAPTOR	ADP-FF-MF-0608	1	
	CASCADE ROOM 60A CIRCUIT BREAKER	UE699	1	

	CASCADE ROOM MAIN SOLENOID	UE072	1	
	EVAP - CAB DARIN HOSE	UC020	10m	
	HEATER SOLENIID VALVE WITH COIL	20088862 UE057	1	
	DRAIN HOSE NOZZLE	UC504	4	
	POWER CABLE FROM EVAP TO CONDENSER BOX FRONT A/C	HRN-TCF8BX-P/F	1	INCLUDES HEAVY DUTY CONNECTORS KIT
	POWER CABLE FROM EVAP TO CONDENSER BOX REAR A/C	HRN-TCF8BX-P/R	1	INCLUDES HEAVY DUTY CONNECTORS KIT

DRIER PLATE ASSEMBLY

DIAGRAM 9

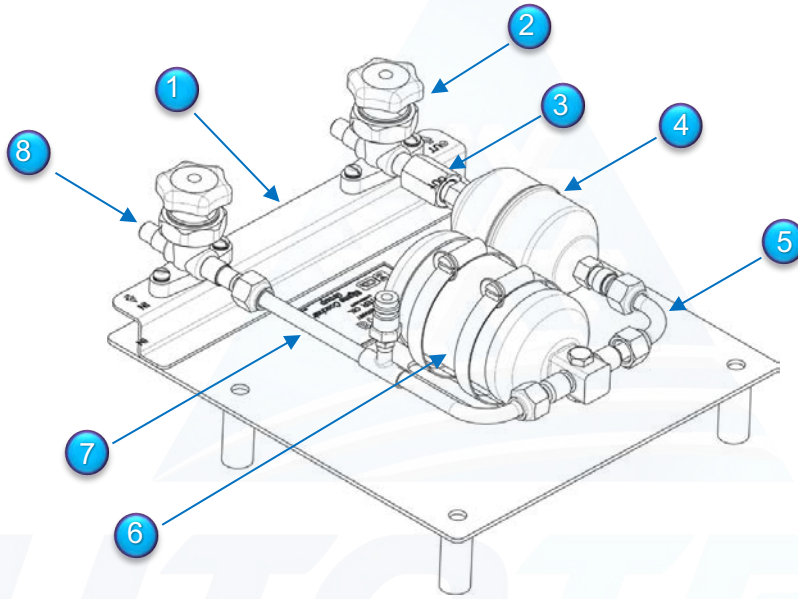

Note: Items numbered are listed in spare parts table



SPARE PARTS
DIAGRAM 9

ITEM NO	DESCRIPTION	AUTO TECH PN	QTY	PHOTO
1	DRIER PLATE ASSEMBLY	AS3874015	1	
2	ISOLATION VALVE	AU517004	2	
3	ADAPTOR ISOLATION VALVE TO FILTER	ADP-FF-06	1	
4*	IN LINE FILTER SMALL SIZE	DR-INL38MF-33	1	

<p>4**</p>	<p>IN LINE FILTER LARGE SIZE</p>	<p>DR-INL38MF-83</p>	<p>1</p>	
<p>5*</p>	<p>PIPE SUIT SMALL IN LINE FILTER DR-INL38MF-33</p>	<p>REFER PAGE 33 LINE 9</p>	<p>1</p>	
<p>5**</p>	<p>PIPE SUIT LARGE IN LINE FILTER DR-INL38MF-83</p>	<p>REFER PAGE 33 LINE 9</p>	<p>1</p>	
<p>6</p>	<p>RECEIVER DRIER FILTER</p>	<p>DR-38MF165</p>	<p>1</p>	 

7	PIPE DRIER FILTER TO ISOLATION VALVE	REFER PAGE 33 LINE 9	1	
8	ADAPTOR FLARE	ADP-FF-MF- 0608	2	
9	PIPE KIT SUIT BOTH IN LINE FILTERS SIZE	DPFP-KIT	1	INCLUDES ALL FLARE PIPES , SUIT BOTH IN-LINE FILTERS



AUTOTECH
MINING

SIGMA ENGINE DRIVEN A/C Cummins Engine

DIAGRAM 10

Note: Items numbered are listed in spare parts table

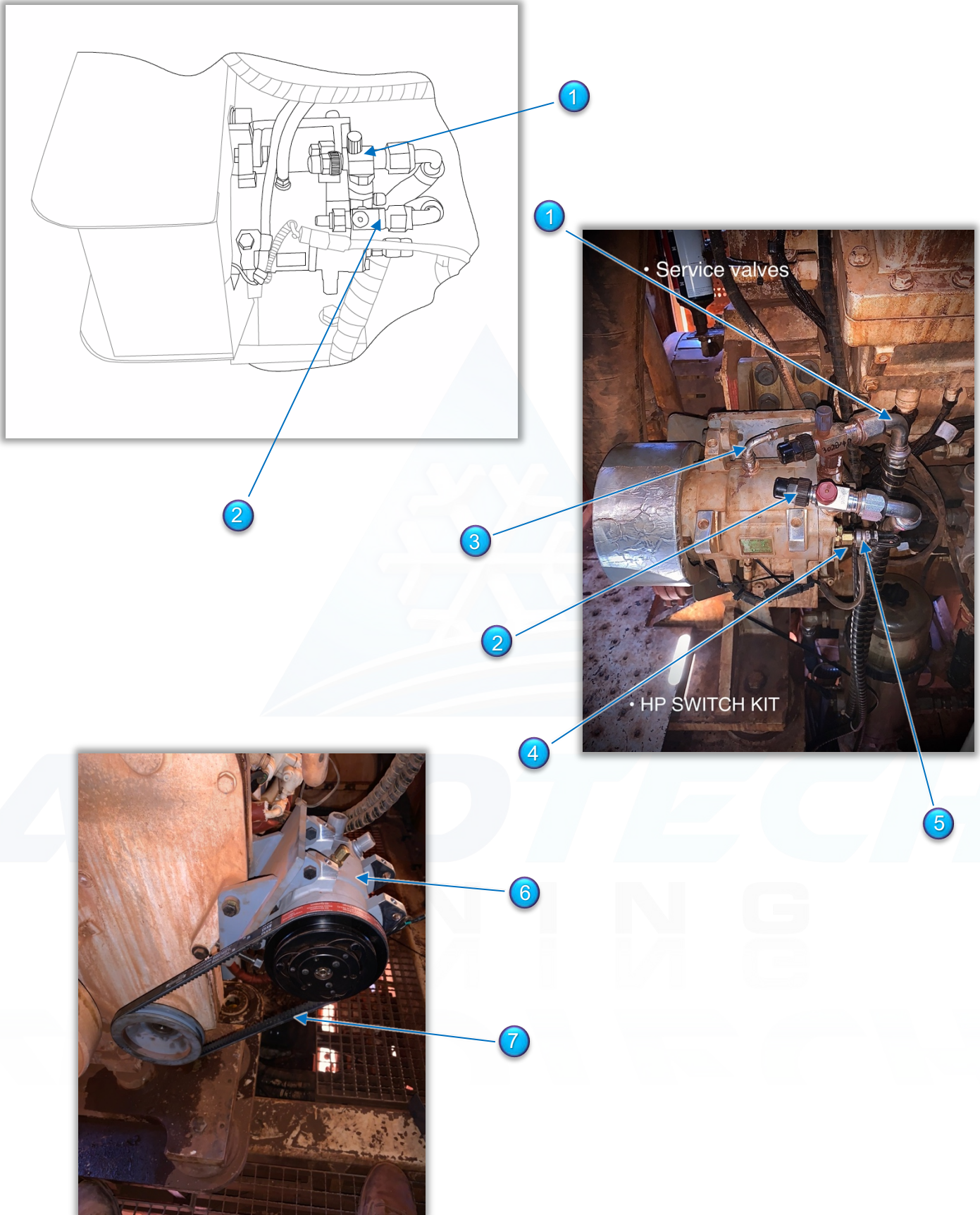
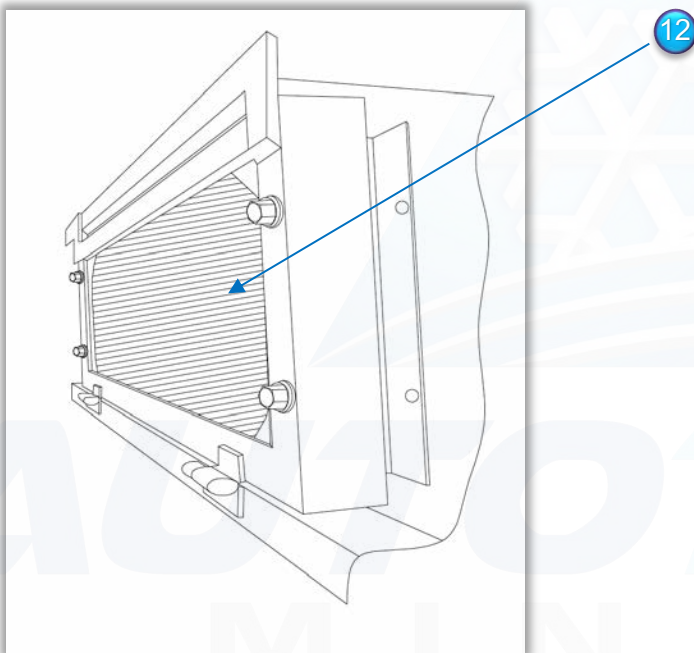
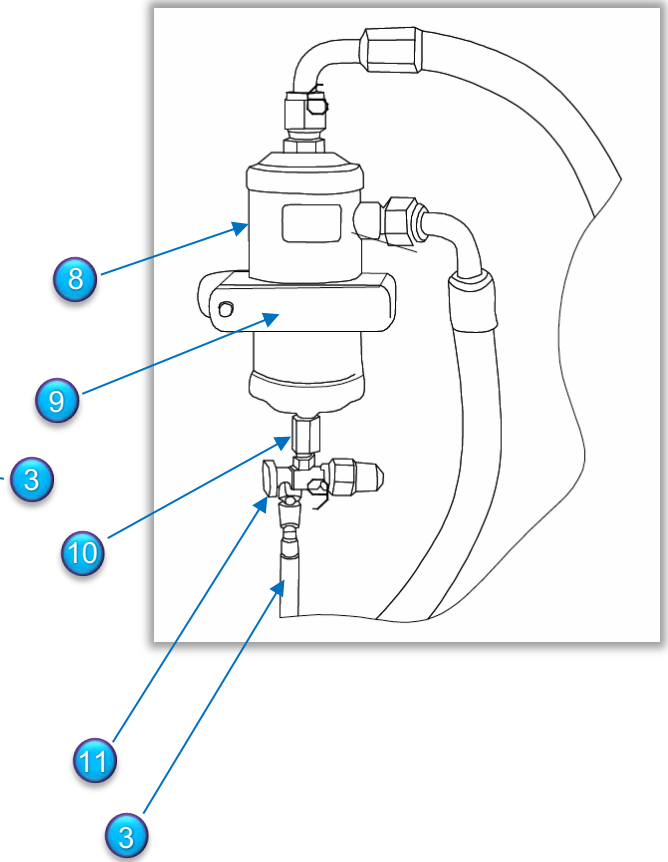



DIAGRAM 11

Note: Items numbered are listed in spare parts table



SPARE PARTS
DIAGRAM 10 , 11

ITEM NO	DESCRIPTION	AUTO TECH PN	QTY	PHOTO
1	SERVICE VALVE LOW SIDE	AU230644	1	
2	SERVICE VALVE HIGH SIDE	AU230640	1	
3	OIL SEPARATOR HOSE & FITTINGS KIT	ATHO-4MC-KIT	1	
4,5 *	HP SWITCH & ADAPTOR KIT	SW-HP-24K-4FF-K	1	 
5	HP SWITCH	AU523655	1	

6	UNICLA COMPRESSOR WITH CLUTCH (CUMMINS ENGINE)	CMUP200EVB-24	1	
7	A/C BELT (CUMMINS ENGINE)	BLT-BX43	1	
8	OIL SEPARATOR FILTER	OSUBMIO-10	1	
9	OIL SEPARATOR CLAMPS KIT	ATCLPOS10-KIT	1	
3,8,9*	OIL SEPARATOR KIT	OSUBMIO-10K	1	
10	OIL SEPARATOR ADAPTOR FLARE	ADP-FF-04	1	

<p>11</p>	<p>OIL SEPARATOR ISOLATION VALVE</p>	<p>AU517202 VLV-MF-04-HN</p>	<p>1</p>	
<p>12</p>	<p>CONDENSER COIL COOLER MOUNT (ORING)</p>	<p>AU1102401</p>	<p>1</p>	 
<p>1,2*</p>	<p>SERVICE VALVES KIT LOW & HIGH</p>	<p>SVLV-10-12-K</p>	<p>1</p>	 

• Please Contact us for CAT Engine A/C compressor.

SIGMA A/C HARNESS

DIAGRAM 12

Note: Items numbered are listed in spare parts table



1



2

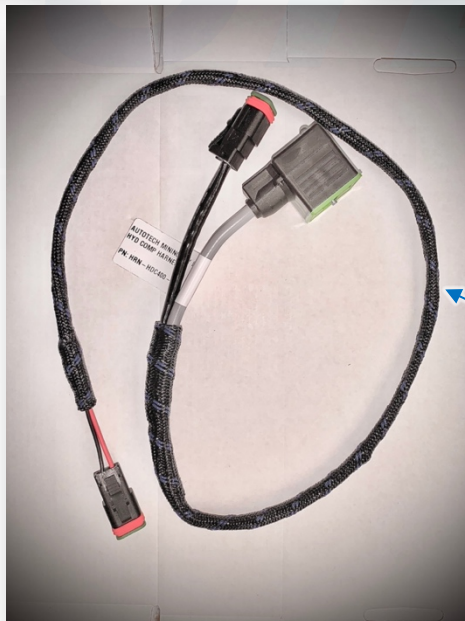
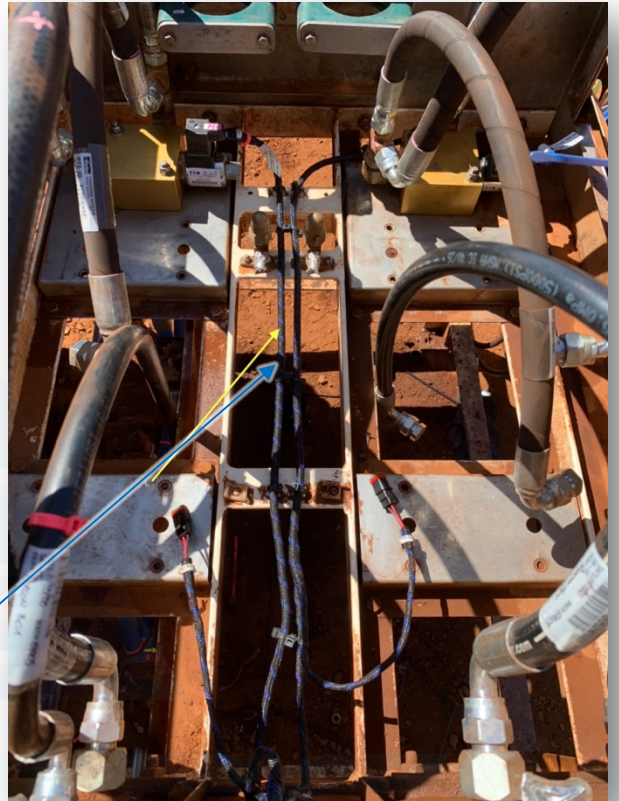

3



AUTOTECH
MINING

SPARE PARTS
DIAGRAM 12

ITEM NO	DESCRIPTION:	AUTO TECH PN	QTY
1	A/C CAB ARMREST FAN CONTROL HARNESS PLUGS KIT	HDP-18-8-KIT	1
2	HDC400 HYDRAULIC COMPRESSOR HARNESS – SUIT BOX WITH YELLOW VALVE BODY	HRN-HDC400-Y	2
3	HDC400 HYDRAULIC COMPRESSOR HARNESS – SUIT BOX WITH SILVER VALVE BODY	HRN-HDC400-S	2
4	HEAVY DUTY CONDENSER FAN HARNESS WITH PLUGS	HRN-TCF8BX	1
5	EARTH LINK CABLE WITH ADAPTOR	HRN-TCF8BX-E	1
6	POWER CABLE WITH HEAVY DUTY PLUG FROM EVAP CAB TO CONDENSER BOX FRONT A/C	HRN-TCF8BX-P/F	1
7	POWER CABLE WITH HEAVY DUTY PLUG FROM EVAP CAB TO CONDENSER BOX REAR A/C	HRN-TCF8BX-P/R	1

**REBUILD EVAPORATOR - CONDENSER UNITS
TEREX & CAT DIGERS**

ITEM NO	DESCRIPTION:	PART NUMBER	EXTRA PARTS TO ADD ON ORDER
1	EVAPORATOR UNIT, MODEL TFC8BX1	TFC8BX1-RECON	- EVAP PLASTIC COVER - WIRING
2	CONDENSER UNIT, MODEL TCF8BX OPTION: X1 OR X2	TCF8BX-RECON	- BOX & LID - FANS
3	NEW UPGRADED CONDENSER UNIT (BOX & LID) MODEL TCF8BX, OPTION: X1 OR X2 FANS TYPE: MAINTENANCE FREE ON LID	TCF8BX	- MAINTENACE FREE FANS



AUTOTECH
MINING

MIDLIFE A/C SERVICE KIT TEREX & CAT DIGGERS

ITEM NO	DESCRIPTION:	PART NUMBER	
1	12 MONTHLY MIDLIFE KIT COOLER MOUNT CONDENSER ENGINE DRIVEN COMPRESSOR	CDCCKIT-12	PLEASE CONTACT US FOR MORE INFORMATION
2	12 MONTHLY MIDLIFE KIT TCF8BX CONDENSER MAINTENANCE FREE FANS ENGINE DRIVEN COMPRESSOR	CDRCKIT-12E CDRCEN-12	PLEASE CONTACT US FOR MORE INFORMATION
3	12 MONTHLY MIDLIFE KIT TCF8BX CONDENSER MAINTENANCE FREE FANS HDC400 HYDRAULIC COMPRESSOR	CDRCKIT-12	PLEASE CONTACT US FOR MORE INFORMATION
4	24 MONTHLY MIDLIFE KIT COOLER MOUNT CONDENSER ENGINE DRIVEN COMPRESSOR	CDCCKIT-24	-INCLUDES NEW CONDENSER -EVAPORATOR SPARE PARTS - <i>NEW UNIT</i> (optional) -ENGINE DRIVEN COMPRESSOR PARTS
5	24 MONTHLY MIDLIFE KIT TCF8BX CONDENSER MAINTENANCE FREE FANS ENGINE DRIVEN COMPRESSOR	CDRCKIT-24E CDRCEN-24	-INCLUDES NEW CONDENSER UNIT -MAINTENANCE FREE CONDENSER FANS -EVAPORATOR SPARE PARTS -ENGINE DRIVEN COMPRESSOR PARTS
6	24 MONTHLY MIDLIFE KIT TCF8BX CONDENSER MAINTENANCE FREE FANS HDC400 HYDRAULIC COMPRESSOR	CDRCKIT-24	-INCLUDES NEW CONDENSER UNIT -MAINTENANCE FREE CONDENSER FANS -EVAPORATOR SPARE PARTS - <i>NEW UNIT</i> (optional) -HYDRAULIC HDC400 COMPRESSOR PARTS

LIEBHERR, CAT DIGGER, D65, PIT VIPER AIR CONDITIONING SERVICE KIT

	12 MONTHLY Part Number	24 MONTHLY Part Number	HOSE KIT PN - Price
R9250 AC1 ENGINE	LD250EN-12	LD250EN-24	LD250EN-HOS
R9250 AC2 HYDRAULIC	LD250HYD-12	LD250HYD-24	LD250HYD-HOS
R9400 AC1 ENGINE	LD9400EN-12	LD9400EN-24	LD9400EN-HOS
R9400 AC2 HYDRAULIC	LD9400HYD-12	LD9400HYD-24	LD9400HYD-HOS
R996 AC1 HYDRAULIC	LD996HYD1-12	LD996HYD1-24	LD996HYD1-HOS
R996 AC2 HYDRAULIC	LD996HYD2-12	LD996HYD2-24	LD996HYD2-HOS
CAT DIGGER ENG AC – COOLER CONDENSER	CDCKKIT-12	CDCKKIT-24	CDCKKIT-HOS
CAT DIGGER ENG AC – REMOTE CONDENSER	CDRCEN-12	CDRCEN-24	CDRCEN-HOS
CAT DIGGER HYD AC – REMOTE CONDENSER	CDRCKIT-12	CDRCKIT-24	CDRCHYDF-HOS CDRCHYDR-HOS TDRCHYDF-HOS TDRCHYDR-HOS
D65 ENGINE DRIVEN	DD65EN-12	DD65EN-24	DD65EN-HOS \$2490
PIT VIPER 271 AC1 HYD	DPV271HYD-12	DPV271HYD-24	DPV271HYD-HOS \$2490
PIT VIPER 271 AC2 RENCOOL	DPV271RC-12	DPV271RC-24	DPV271RC-HOS
SK DRILL REAR HYD BELT DRIVE	DSKRHYDB-12		DSKRHYDB-HOS

AUTO TECH MINING

SUPPLY OEM AIR CONDITIONING PARTS – REBUILD AC UNITS – OEM HOSE KIT

info@autotechmining.com.au

A/C HOSE KIT – CAT & TEREX DIGGERS

ITEM NO	DESCRIPTION	PART NUMBER	
1	COOLER MOUNT TYPE CONDENSER ENGINE DRIVEN COMPRESSOR OPTION: FLARE & ORING CONDENSER FITTINGS	CDCCEN - HOS	INCLUDES: CORRECT HOSE LENGHTS CORRECT HOSE SIZES, FITTINGS, BULKHEADS, CLAMPS
2*	REMOTE TCF8BX CONDENSER TOWER ENGINE DRIVEN COMPRESSOR OPTION: FLARE & ORING CONDENSER FITTINGS	CDRCEN - HOS	INCLUDES: CORRECT HOSE LENGHTS CORRECT HOSE SIZES, FITTINGS, BULKHEADS, CLAMPS
3*	REMOTE TCF8BX CONDENSER TOWER HYDRAULIC DUAL COMPRESSOR HDC400 OPTION: FLARE & ORING CONDENSER FITTINGS	CDRCHYD - HOS	INCLUDES: CORRECT HOSE LENGHTS CORRECT HOSE SIZES, FITTINGS, BULKHEADS, CLAMPS
4	OIL SEPARATOR HOSE KIT	ATHO - 4MC - KIT	CRIMPPED & READY TO FIT SUIT: ENGINE DRIVEN COMPRESSOR
5**	CUSTOM HOSE KIT	Contact us for more detail	Email: admin@autotechmining.com.au



MINING RATED WORK LIGHT



KELVIN COLOUR TEMPERATURE

The Kelvin Colour Temperature scale describes the colour of the light output of a lamp. This has varied from the traditional Halogen at 3000K which is quite yellow, through to blue/white LED which is typically around 6500K. When LED first came out people liked the crisp white light compared to the yellow halogen. However, when working in very dusty environments, the white LED's reflect off the dust, causing a lot of glare. To overcome this Ultra Vision has introduced a 3000K and 4000K LED option. This gives the advantages of solid-state LED but also the advantages of halogen for penetrating dust and reducing glare. With the technology improvements in LED there are now LED's available for the complete colour temperature spectrum.

If you are unsure what is best for your application speak to our team to arrange a demonstration or trial.

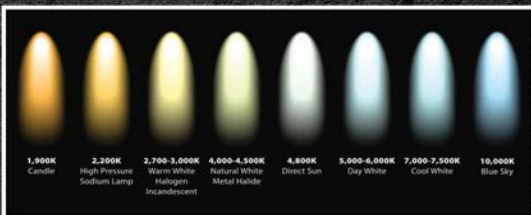
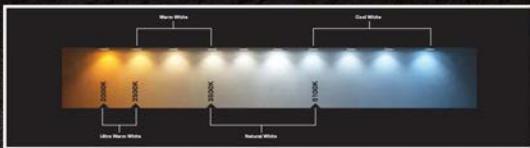

info@autotechmining.com.au

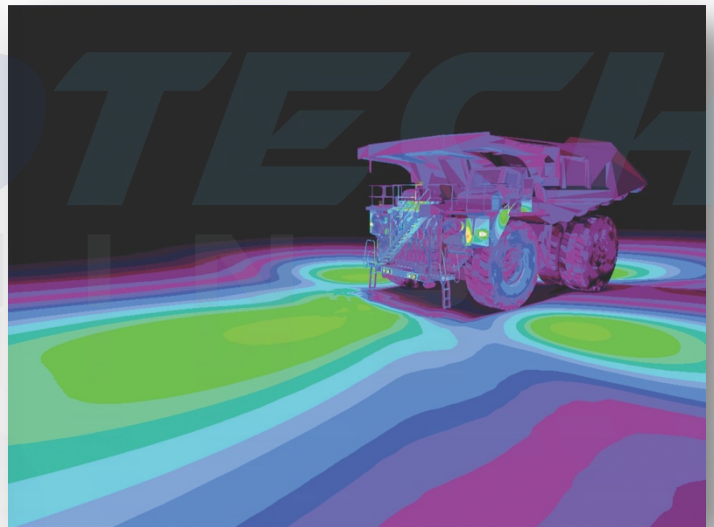



Part Enquiry:

admin@autotechmining.com.au

0412 228 671



CAT793F

www.autotechmining.com.au 0412 228 671 info@autotechmining.com.au

CAT785



www.autotechmining.com.au 0412 228 671 info@autotechmining.com.au

CAT789C



www.autotechmining.com.au 0412 228 671 info@autotechmining.com.au

CAT777 Service Cart



www.autotechmining.com.au 0412 228 671 info@autotechmining.com.au

CAT 24M Grader



www.autotechmining.com.au 0412 228 671 info@autotechmining.com.au



ITEM NO	DESCRIPTION:	PART NUMBER	 
1	<p>ENFORCER MINING RATED HEAVY DUTY WORK LIGHT, 25 -110 DEG 24 ONLY OR 9 -36v 60W</p> <p>HEAT & WATER RESISTANT</p>	<p>WL12L60F-M WL12L60F-24 WL12L60WF-M WL12L60WF-24</p>	
2	<p>INVADER MINING RATED HEAVY DUTY WORK LIGHT, 25 -110 DEG 24 ONLY OR 9-36v 50W</p> <p>HEAT & WATER RESISTANT</p>	<p>WL9L50F-M WL9L50F-24 WL9L50WF-M WL9L50WF-24</p>	
3	<p>LED WORK LIGHT MINE MASTER FLOOD 16-58V 180W</p> <p>HEAT & WATER RESISTANT</p>	<p>WLMM180F5-24</p>	

ITEM NO	DESCRIPTION:	PART NUMBER	 
4	<p>LED WORK LIGHT MINE MASTER FLOOD 16-58V 340W</p> <p>HEAT & WATER RESISTANT</p>	WLMM340F5-24	
5	<p>ATOM MINING RATED HEAVY DUTY WORK LIGHT, 70 DEG 9-36v , 40W</p> <p>HEAT & WATER RESISTANT</p>	WL9L40F-M	
6	<p>ATOM HEAVY DUTY MAINTENANCE LIGHT - WORK LIGHT 6 LED 70 -110 DEG 10W & 25 W</p> <p>HEAT & WATER RESISTANT</p>	WL6L12WF/B-M WL6L25F-M	 

	<p>RAPTOR HEAVY DUTY DRIVING LIGHT 170 MM - 60 W 200 mm -110 W 25 -70 DEG</p> <p>BRACKET & WIRING KIT AVAILABLE</p>	<p>Contact us For price & availability</p>	
	<p>RAPTOR LIGHT BAR 12 LED 380mm</p> <p>BRACKET & WIRING KIT AVAILABLE</p>	<p>Contact us For price & availability</p>	
	<p>RAPTOR LIGHT BAR 18 LED 530mm</p> <p>BRACKET & WIRING KIT AVAILABLE</p>	<p>Contact us For price & availability</p>	
	<p>RAPTOR LIGHT BAR 24 OR 36 LED 680mm</p> <p>BRACKET & WIRING KIT AVAILABLE</p>	<p>Contact us For price & availability</p>	
	<p>FLARE LIGHT BAR</p> <p>BRACKET & WIRING KIT AVAILABLE</p>	<p>Contact us For price & availability</p>	

Part Enquiry:

 admin@autotechmining.com.au

 0412 228 671



www.autotechmining.com.au